

SHEAR BLOCK
OUTSIDE SET

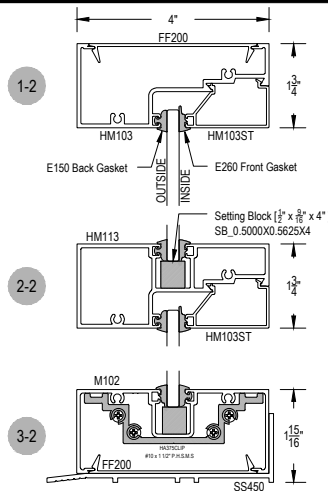

SHEAR BLOCK
INSIDE SET

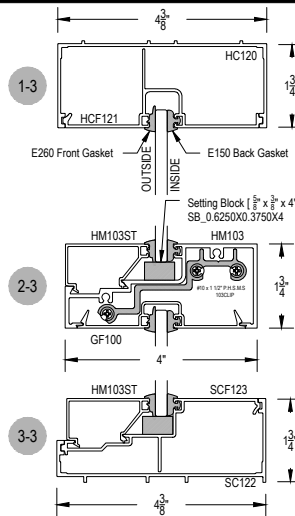

COMPENSATING STICK
OUTSIDE SET

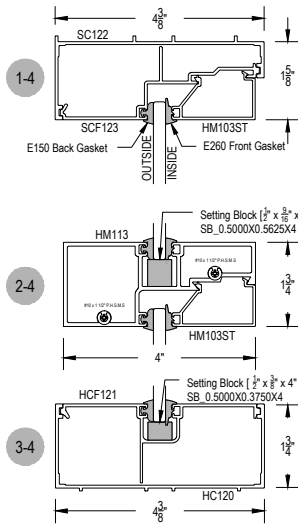
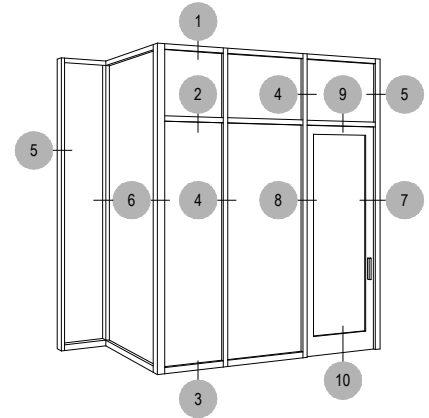

COMPENSATING STICK
INSIDE SET

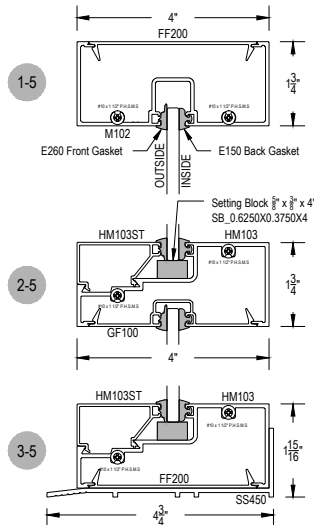

SCREW SPLINE
OUTSIDE SET

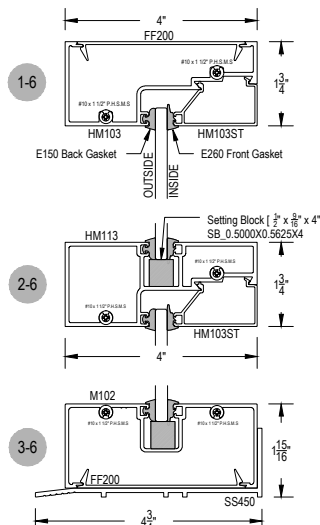

SCREW SPLINE
INSIDE SET

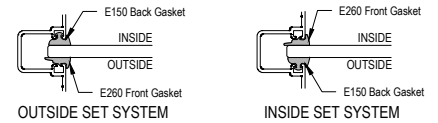

GASKET PLACEMENT
FOR INSIDE/OUTSIDE
SET SYSTEMS

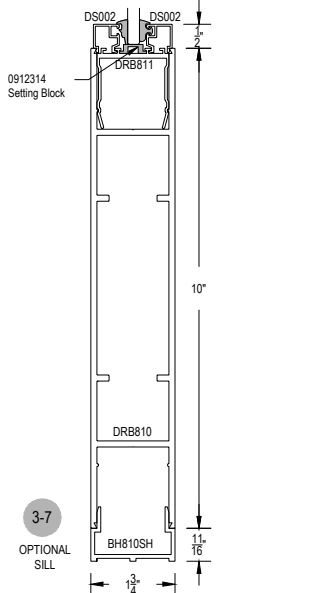

3-7
OPTIONAL
SILL

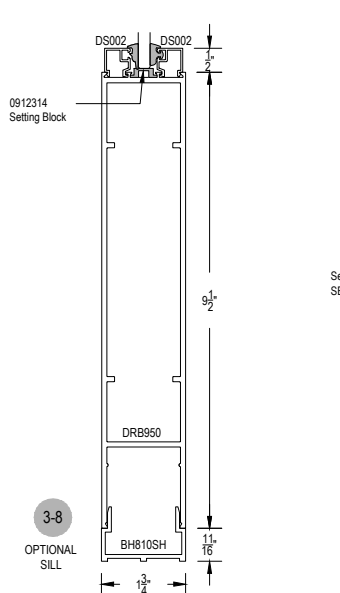

3-8
OPTIONAL
SILL

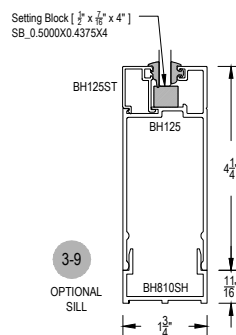

3-9
OPTIONAL
SILL

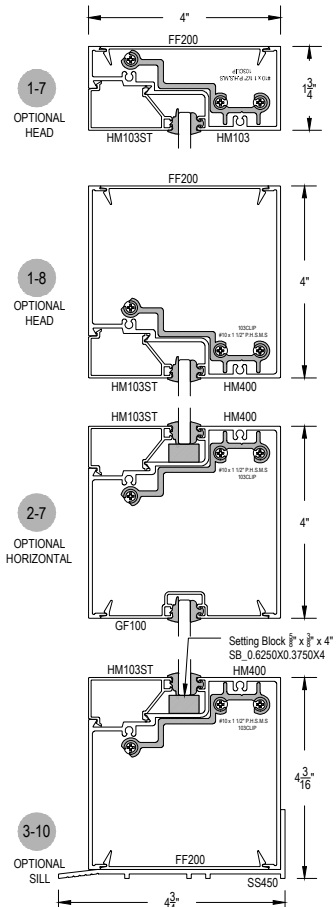

1-7
OPTIONAL
HEAD

2-7
OPTIONAL
HORIZONTAL

3-10
OPTIONAL
SILL



A400 Series

Description: 1 3/4" x 4" Center Glazed for 1/4" Glass

Function: Storefront

Detail: Verticals

Scale: 3" = 1'-0"

SHEET 2 OF 3

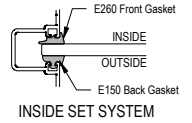
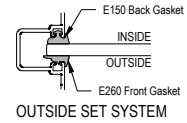
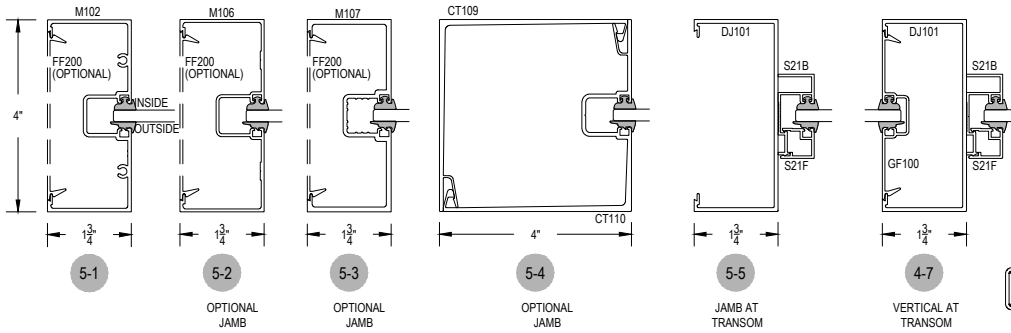
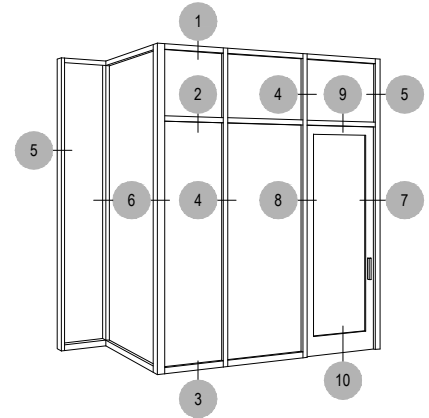
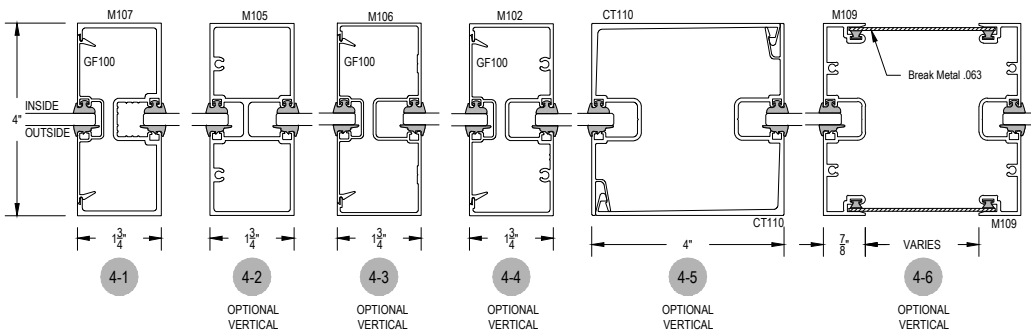

GASKET PLACEMENT FOR INSIDE/OUTSIDE SET SYSTEMS

